

**Modul 2**

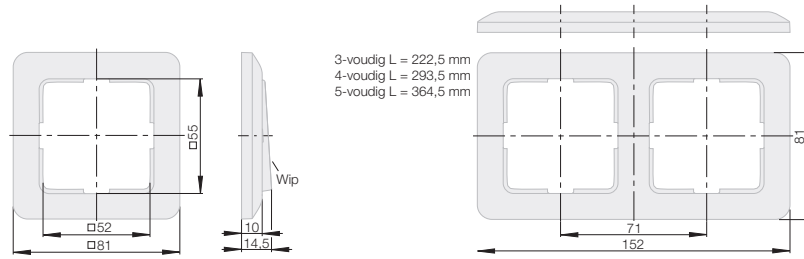

**Berker S.1**

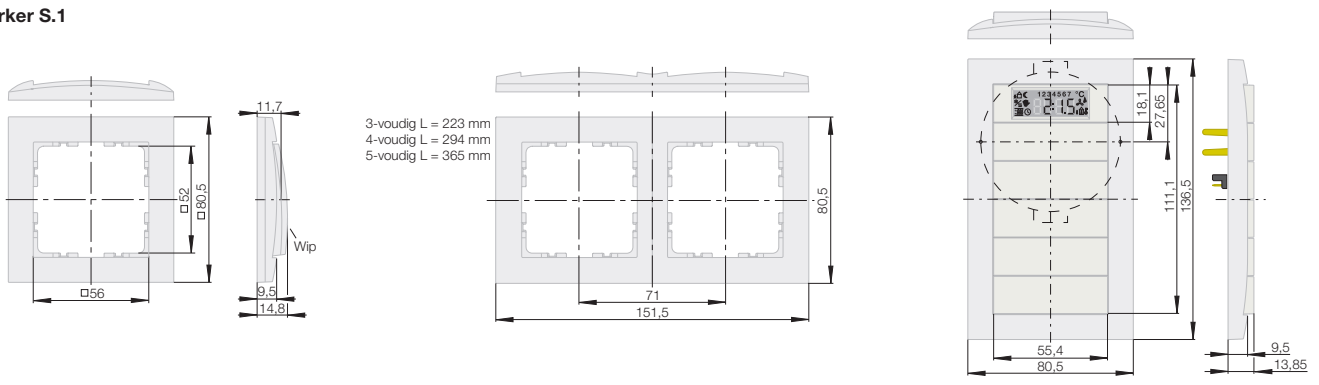

**Berker B.3**

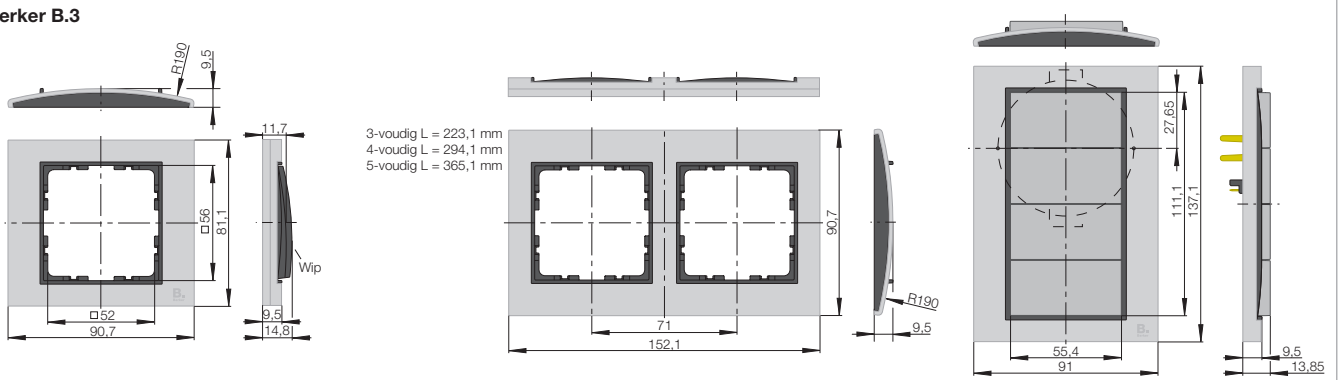

**Berker B.7**

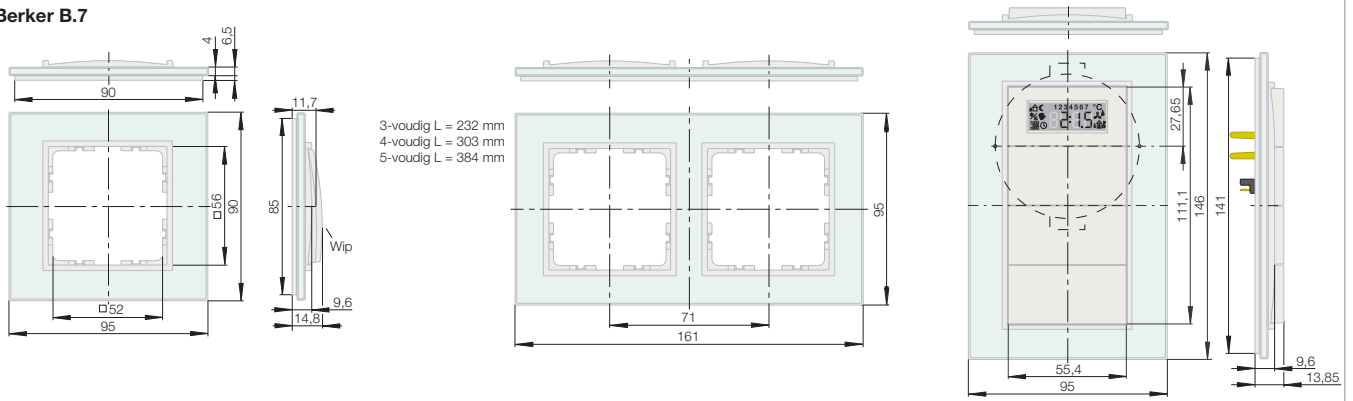

**Spatwaterdicht, inbouw IP44**

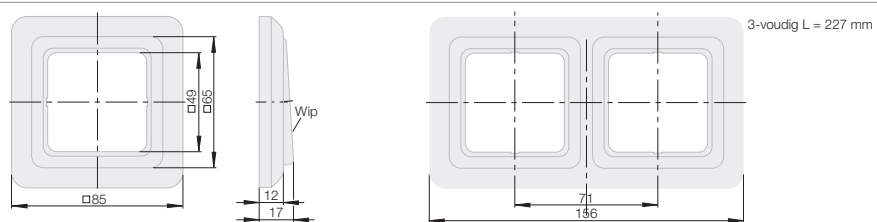

**Berker Q.1**

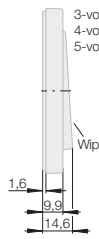
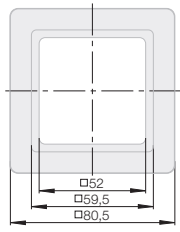

3-voudig L = 222,5 mm  
4-voudig L = 293,5 mm  
5-voudig L = 364,5 mm

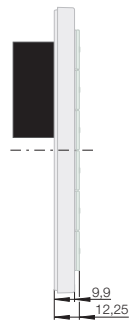
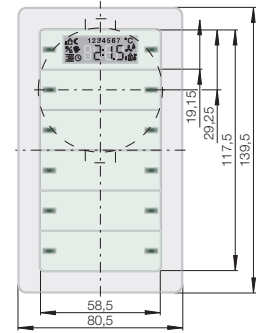
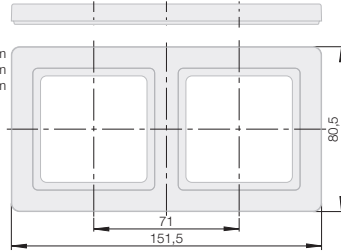

**Berker Q.3**

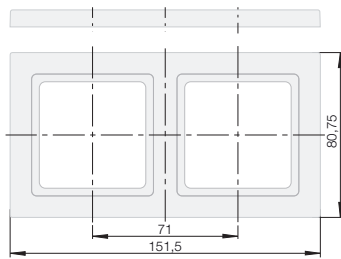
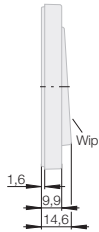
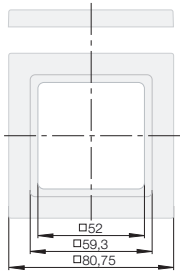

3-voudig L = 222,5 mm  
4-voudig L = 293,5 mm  
5-voudig L = 364,5 mm

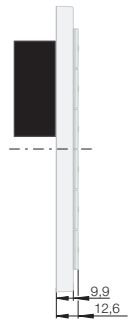
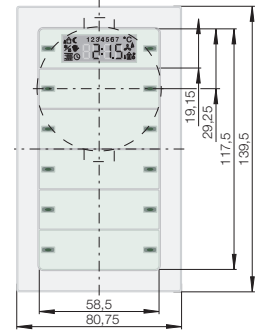

**Berker K.1/K.5**

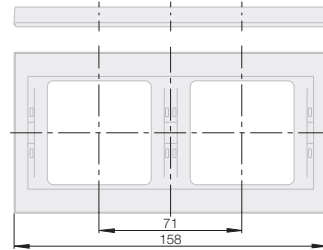
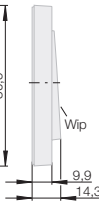
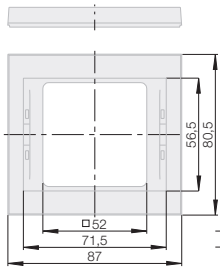

3-voudig horizontaal L = 229 mm  
4-voudig horizontaal L = 300 mm  
5-voudig horizontaal L = 371 mm

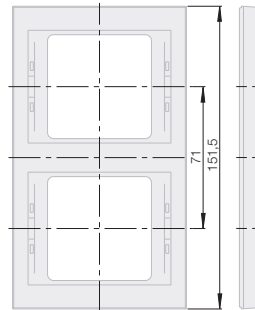

3-voudig verticaal L = 222,5 mm  
4-voudig verticaal L = 293,5 mm  
5-voudig verticaal L = 364,5 mm

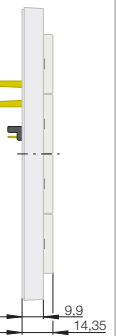
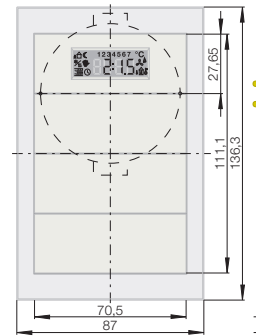

**Berker Arsys**

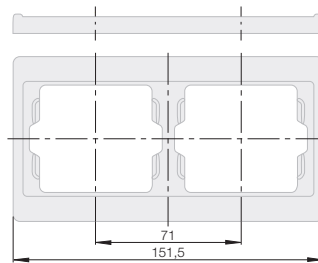
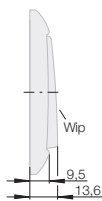
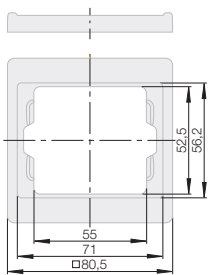

3-voudig L = 222,5 mm  
4-voudig L = 293,5 mm  
5-voudig L = 364,5 mm

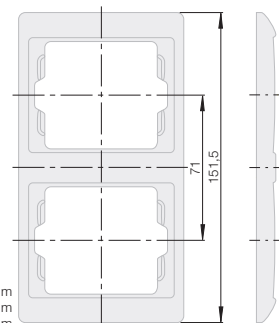

## Berker R.1

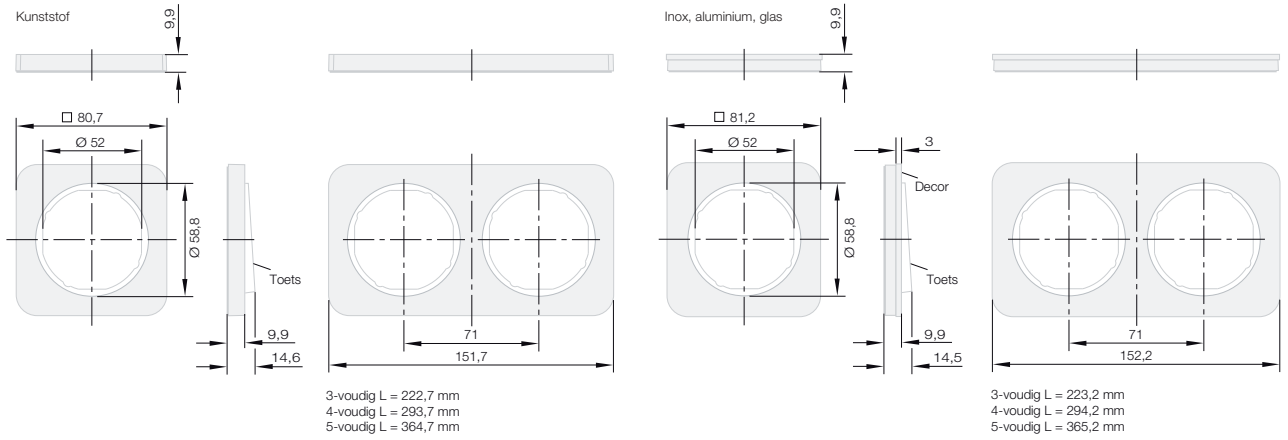

## Berker R.1 - Touch Sensor

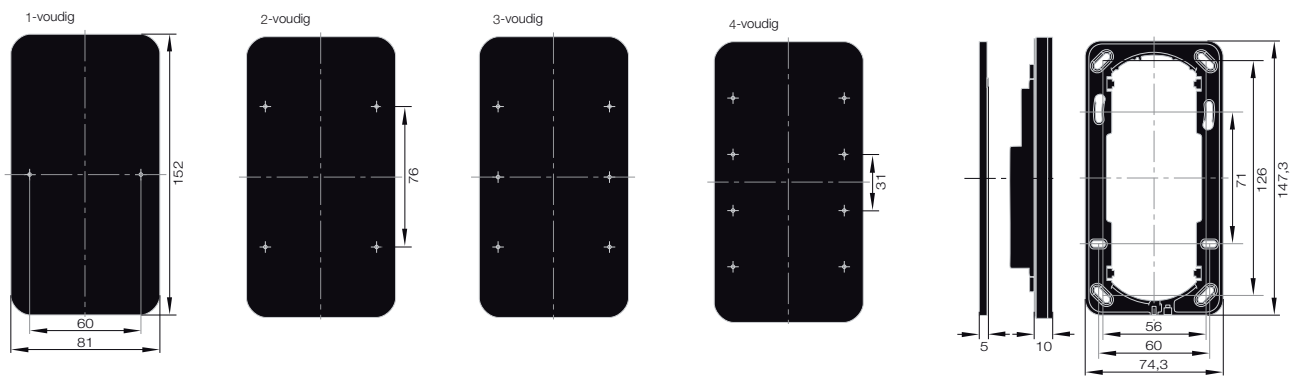

## Berker R.1 - Touch Sensor met Kamerthermostaat

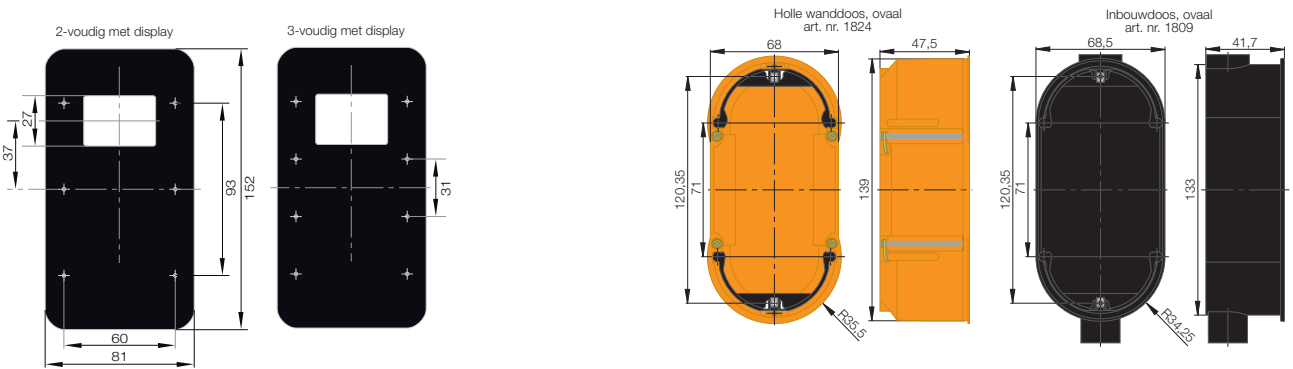

## Berker R.3

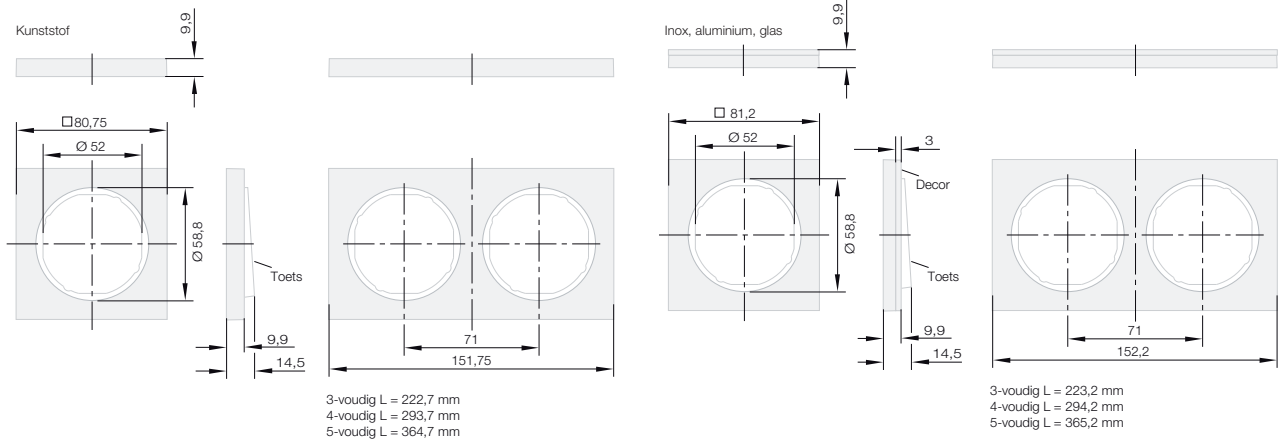

## Berker R.3 - Touchsensor

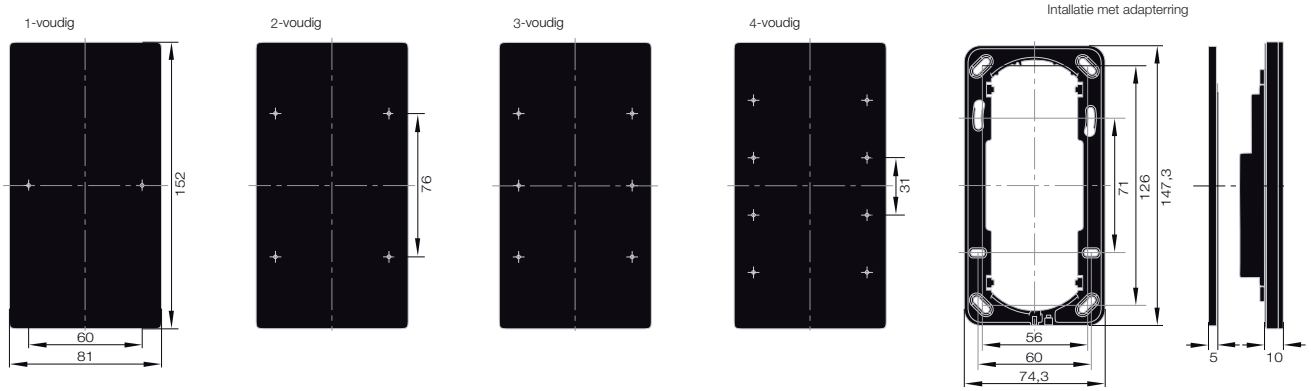

## Berker R.3 - Touchsensor met kamerthermostaat

